

POYNTING

BEYOND A CONNECTED LIFE



PUCK SERIES

www.ime.de

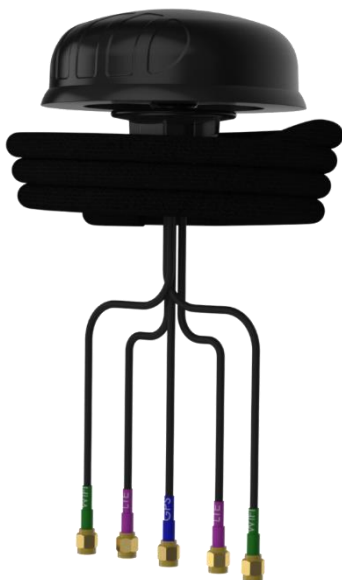

User Guide

Index

| | | |
|--|------------------------------|------------|
| 1. | Packing Check List | 2 |
| 2. | Introduction | 7 |
|  | | www.ime.de |
| 3. | Antenna Mounting Precautions | 14 |
| 4. | Cable Routing | 14 |
| 5. | Safety | 15 |

Stay Updated: Access the Latest Installation Resources

The information in this manual is intended to provide general guidelines for installing your POYNTING antenna. For the most up-to-date and comprehensive mounting and installation instructions, as well as the latest product information, please visit our website: <https://poynting.tech/>

We recommend checking the website periodically for any updates or revisions to ensure you have the most current information for optimal product performance.

1. Packing Check List

| Item | Description | Quantity |
|--|---|--|
| 1. | *PUCK-V2 Antenna Only | 1 |
|  | M4 x 10mm Flat Head Stainless Steel Screws | 4 (Attached to the antenna) |
| 3. | 35mm Threaded Spigot | 1 (Attached to the antenna) |
| 4. | 75mm Threaded Spigot | 1 |
| 5. | Magnetic Base | 1 |
| 6. | Pole/Wall Mount Bracket | 1 |
| 7. | Plastic Nut | 1 (Attached to the antenna) |
| 8. | Adhesive Foam Seal | 1 |
| 9. | Grip Extenders | 5** (Attached to the antenna) |
| 10. | SMA (F) to RP-SMA (M) Adapter | 2** |
| 11 | Base Seal | 1 |
| 12 | Spigot seal | 1 |

*Antenna will differ with different versions

**Quantity will differ with different versions

Appearance of components

Antenna Unit



www.ime.de

M4 x 10mm Flat head Stainless Steel Screws



35mm Threaded spigot

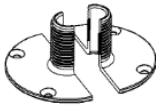

75mm Threaded female spigot



Magnetic Base

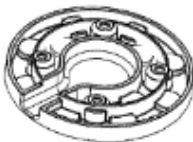

Pole/ Wall Mount Bracket



ime Plastic Nut

www.ime.de

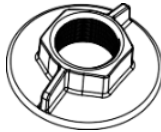

Adhesive Foam Seal



*SMA(F) to RP-SMA(M) Adapters and Grip Extenders

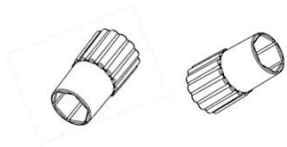

Base Seal and Spigot Seal

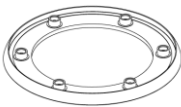

**Antenna with Wi-Fi only*

Tools Required

Drills (Pilot drill (3mm) and Hole saw (22mm) or step drill (4-22mm))



www.ime.de

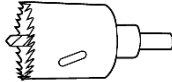

Impact Drilling Machine



Hammer



Safety Goggles



27mm Spanner/Wrench



Masking Tape



www.ime.de

Centre Punch

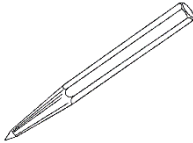

Drilling Template

(Available on www.poynting.tech/downloads)

2. Introduction

This User Guide provides information on the installation instructions for the omni-directional antenna (PUCK-V2 Series).

Antenna Configuration 1

www.ime.de

Threaded Spigot Mounting

Use the Drill template below or download the 1:1 drill template from

<http://www.poynting.tech/downloads>.

- Choose the mounting location carefully and a position at least 50cm from heat sources, with a clear line of sight to the sky.
- Once you have decided on the location and checked that there are no obstructions such as cables or channels below the mounting surface, for the fastening nut and cables to pass through, use the downloaded 1:1 drill template to mark the mounting location.
- To prevent the marking tool or drill from sliding off course, use masking tape over the drilling point to help hold the drill point in place. The masking tape also prevents hot shavings from the drill or hole saw which could penetrate and damage the painted surface.
- Clean the entire surface on which you plan to mount the antenna. Cleaning is done so as not to damage the vehicle's paint and to ensure good contact of the foam surface to the mounting area.
- Alcohol wipes can be used to remove oil and dirt from the surface.
- The 35mm threaded Spigot should be used to secure the antenna to a surface structure of 20mm thickness or less. Likewise, the 75mm threaded Spigot should be used to secure the antenna to a surface structure of 60mm thickness or less.

Securing the antenna

- Remove the plastic nut from the antenna.
- Fasten the required spigot with the Flat head screws.
- Clean the plastic surface of the antenna base and threaded spigot.
- Insert the antenna cables inside the provided Base Seal.
- Carefully slide the antenna cables through the drilled hole.
- At the interior of the mounting surface, Insert the antenna cables into the provided Spigot Seal and push it up to the bottom of the mounting surface through the spigot.
- Tighten the plastic nut onto the Spigot so that it compresses the Base and Spigot Seal.



www.ime.de

Note: Be careful not to overtighten the nut.

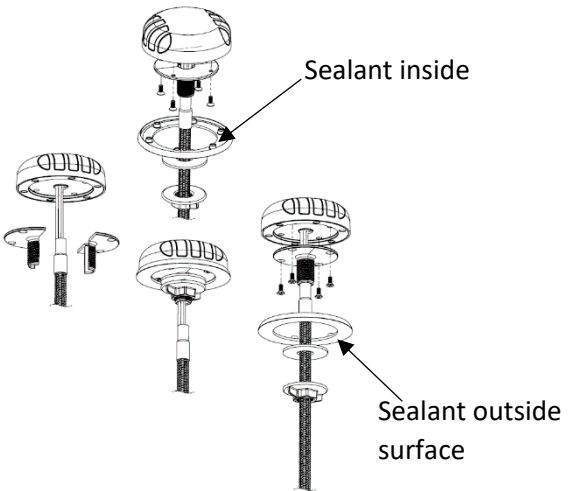

Important Information for Spigot Mount Antenna Installation

To ensure optimal functionality and protect your vehicle from potential water damage, please follow these guidelines for spigot mount installations of your POYNTING antenna:

Sealant is Key: Use a high-quality waterproof kitting substance like SIKA or Dekalin specifically chosen for your application. Apply the sealant meticulously around the spigot where it enters your vehicle as well as on the inside and outside surfaces of the base seal for extra ingress protection in harsh environments.



www.ime.de

Gradual Tightening: After applying the sealant, tighten the spigot nut gently, ensuring the antenna sits flush without excessive pressure. Allow the sealant to dry completely before final tightening.

Enhanced Protection for Frequent Washing: If your vehicle encounters frequent washes with strong detergents or chemicals, we strongly recommend applying additional sealant around the entire antenna base for comprehensive protection against water ingress.

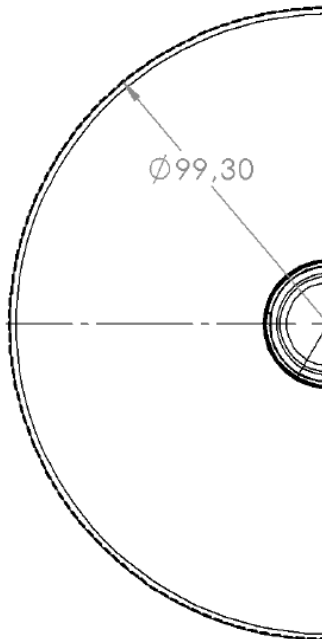

Exploded View

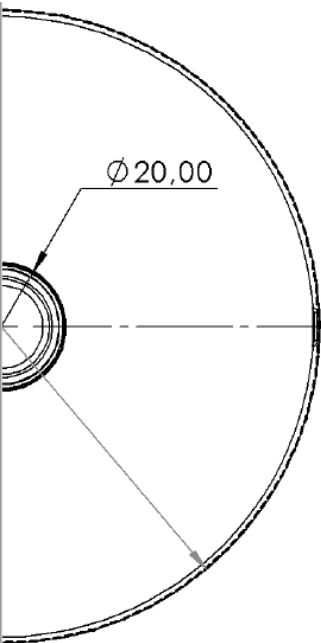
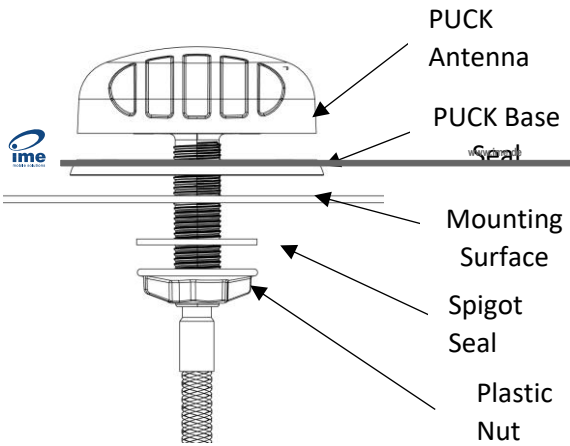

Antenna Configuration 2

Adhesive Mounting

- Clean the entire surface on which you plan to stick the antenna.
- Remove the nut and short spigot from the antenna.
- Secure the magnetic base to the antenna with flat head screws.
- Peel off the wax paper layer and stick the foam seal to the magnetic base.
- Peel off the second wax paper layer and firmly press the antenna down onto the surface.
- Route the cable as required.



www.ime.de

Exploded View

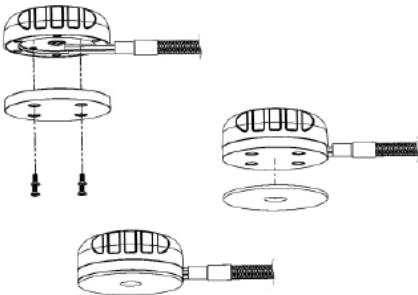

Antenna Configuration 3

Magnetic Mounting

- Clean the entire surface on which you plan to stick the antenna.
- Remove the nut and short spigot from the antenna.
- Secure the magnetic base to the antenna with flat head screws.
- Place the antenna onto the magnetic surface.
- Route the cable as required.



www.ime.de

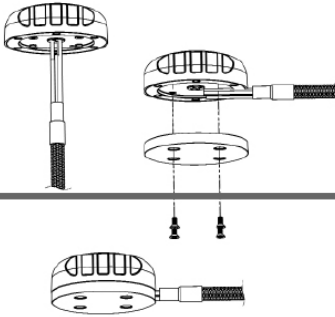

Magnetic surface for Optional Magnet Base kit installation 

Antenna Configuration 4

Pole Mounting

- Lay the antenna out at the installation site.
- Attach the bracket onto on to the base of the antenna using four Flat head screws.
- Secure the cable tie or hose clamp around the bracket and pole until the bracket is secured to the pole.

Vertical Pole Mounting

Internal Pole Mount

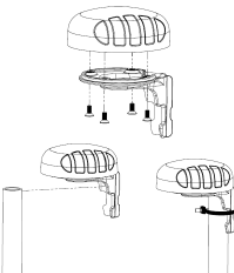

External Pole Mount

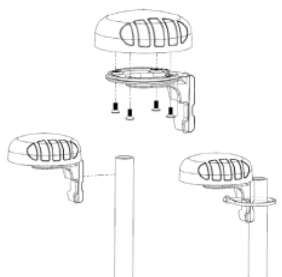

Horizontal Pole Mounting

Internal Pole Mount

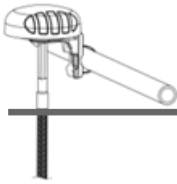

External Pole Mount

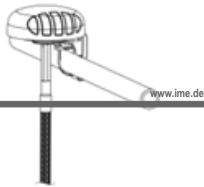

Antenna Configuration 5

Wall Mounting

- Select a suitable place for mounting the antenna.
- Using the wall mount bracket as a guide, mark two points to drill on the wall.
- Use a masonry drill bit to drill a cable entry hole to fit the connector.
- Place the bracket over the two holes and line up the holes in the bracket with the holes in the wall.
- Insert the two knock-in screws to mount the bracket to the wall.

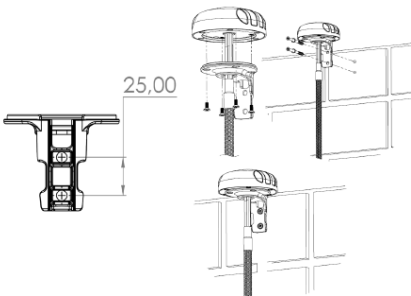

3. Antenna Mounting Precautions

- Place the antenna at the highest point of the vessel and ensure that there are no obstructions surrounding the antenna.



www.ime.de

- to avoid communication interference, ensure that the antenna is placed at least 0.5m away from other antennas and metal objects.
- Avoid installing the antenna near the vessel's chimney, as the smoke and soot emitted by the chimney can obstruct the signal level achieved by the antenna.
- Install the antenna away from the vessel's heat sources and flammable gases.

4. Cable Routing

- Survey the planned cable route and look for any blocked passages. Consider alternate routes to find the best available path. If extension cables are needed, refer to the cable configuration diagram. Always keep the cables as short as possible to make sure that minimum cable losses are achieved.

Note: Take advantage of any existing cable channels e.g. wiring conduits to route the cables.

- Avoid running cables through components or sharp apertures that may cause excessive chafing. Doing so may erode the jacket and break signal continuity. Also, avoid kinking, pinching, or twisting a cable during a run.

When handling the antenna cables, you must follow these basic rules:

- Never pull on the cable connectors; pull only on the cable.
- Never run cables in a manner that interferes with the driver's ability to safely operate the vehicle.
- Tighten the connectors and ensure that the cables don't rattle loose.

5. Safety

- If you are installing an antenna for the first time or unsure about how to install your antenna, obtain the help of a professional installer.
- Carefully survey the installation site before installation to locate secure handholds, dangerous conditions, and the safest and most convenient placement for ladders if necessary.
- The antenna may not be used as a climbing or pulling device.
- Considerations must be taken when mounting the antenna so that people do not hang or pull on it.
- When installing your antenna, remember:
 1. Do not install on a wet or windy day or when there is lightning or thunder in the area.
 2. Wear shoes with rubber soles and heels, protective clothing (long-sleeve shirt or jacket), and rubber gloves.
 3. Avoid installation while under the influence of drugs, alcohol, or medication.

4. Make sure that any loose-fitting jewelry or clothing is secured and tie back long hair as they can get caught in moving parts during installation.
5. If the antenna assembly starts to fall, get away from it and let it fall to avoid harming yourself.



- When drilling remember:
 1. Use safety goggles when drilling the holes.
 2. Avoid using bits that are dull, bent, or damaged.
 3. Be aware of where your fingers are to the drill bit when using the drilling machine.
 4. To stop the drilling machine, let the drill chuck come to a complete stop on its own. Do not grasp the chuck to stop the drill bit.
 5. Avoid awkward hand positions where a sudden slip could cause a hand to move into the drill bit or cutting tool.

CAUTION:

Antennas must be installed to provide a separation distance of at least 20cm from all persons to comply with SAR (Specific Absorption Rate) RF Exposure requirements.



European Waste Electronic Equipment Directive
2002/96/EC

Please ensure that old waste, electricals,
and electronics are recycled.



Directive 2011/65/EU (RoHS 3)
This product is fully compliant with the RoHS 3
directive.



South Africa

Unit 4, N1 Industrial Park
Landmarks Ave
Samrand, 0157
South Africa
Tel: +27 12 657 0050
info@poynting.tech

USA

1804 Owen Court,
Suite 104, Mansfield,
TX 76063
Tel: +1 817 533-8130
sales-us@poynting.tech

Europe

Kronstadler Straße 4,
81677 München
Germany
Tel: +49 89 2080 265 38
Mob.: +49 176 529 733 50
sales-europe@poynting.tech